

ID	Description	Date	By	Appr.
A				

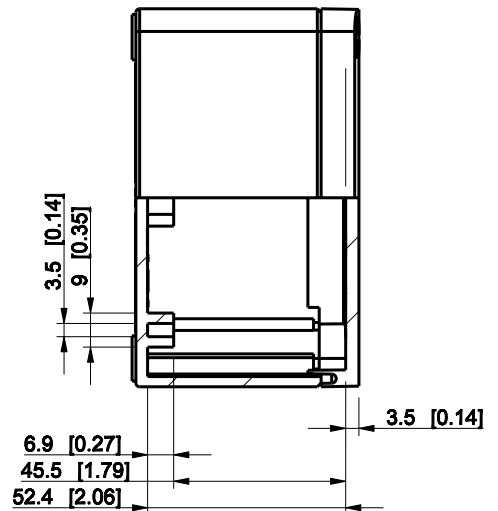
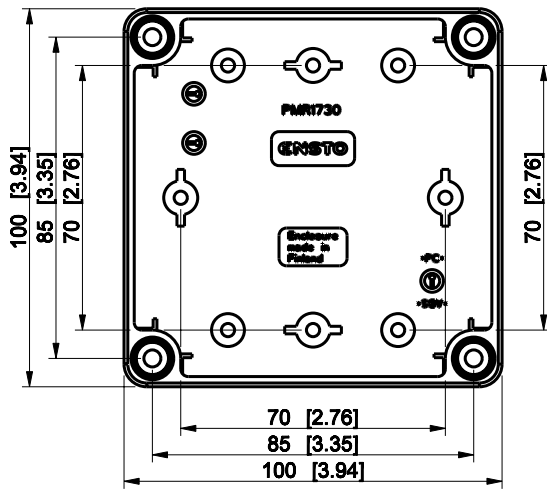
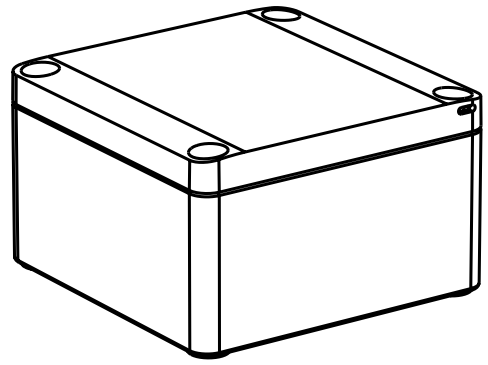
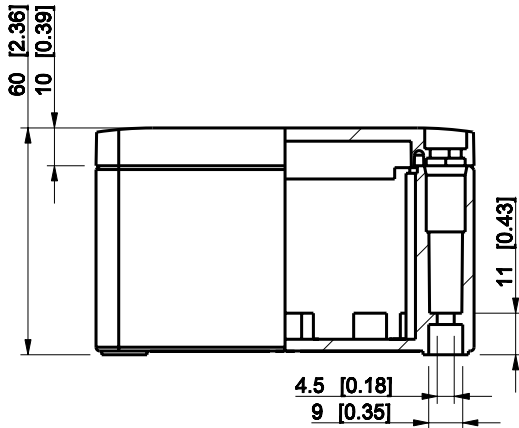

Dimensions in mm [inches]

Material: ABS	Color: RAL 7035
---------------	-----------------

Supplier:	Tool No:	Weight [kg]: 0.17	Volume:
-----------	----------	-------------------	---------

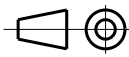

**SABP101006G**

Scale	Date	04.12.08
1:2	By	PKos
-	Checked	
-	Ctrl	

Replaces:	
Replaced:	
Drw No:	- A
Ref:	Cubo S
Code:	SABP101006G
Sheet No:	

model SABP101006G PART  
drawing CUBOS\_3.DRAWING