

ID	Description	Date	By	Appr.
A				

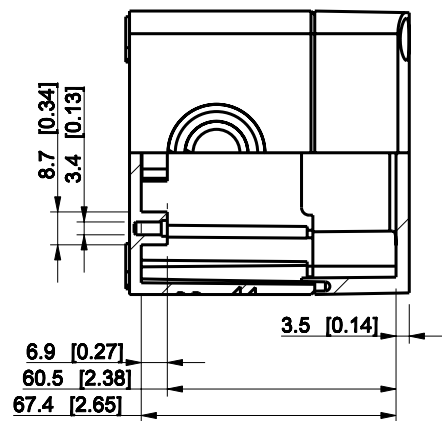
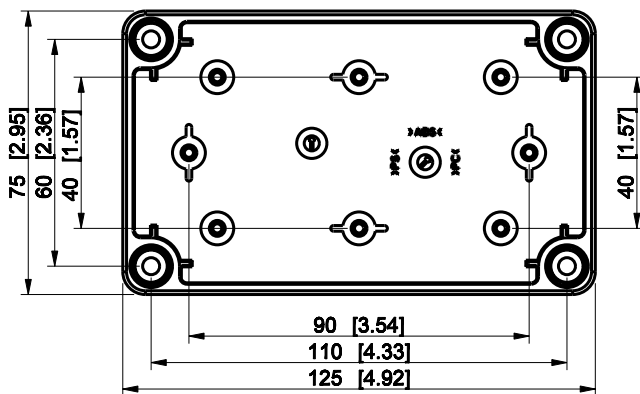
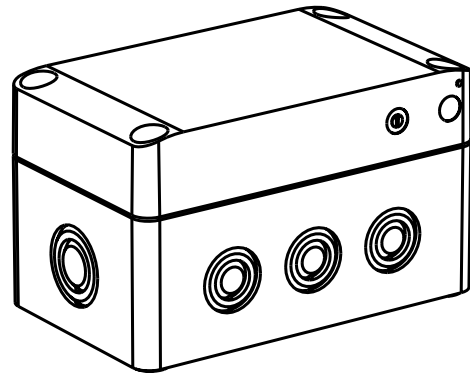
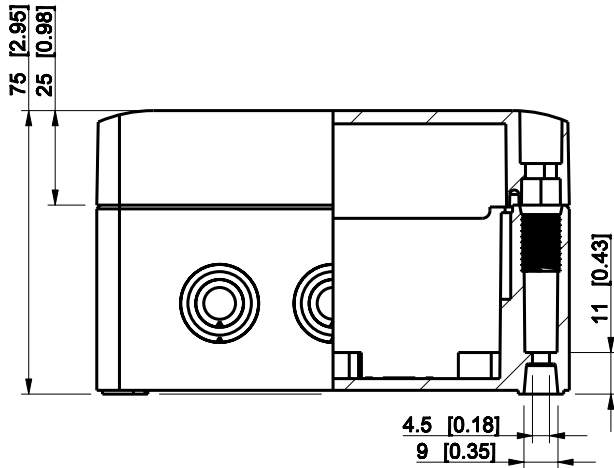

Dimensions in mm [inches]

Material: Polycarbonate, fiberglass-reinforced	Color: RAL 7035
--	-----------------

Supplier:	Tool No:	Weight [kg]: 0.19	Volume:
-----------	----------	-------------------	---------

ENSTO
ENSTO CONTROL OY

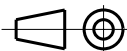

SPCM081308T

Scale	Date	08.12.08
1:2	By	PKos
-	Checked	
-	Ctrl	

Replaces:
Replaced:
Drw No: - A
Ref: Cubo S
Code: SPCM081308T
Sheet No:

model SPCM081308T PART
drawing CUBOS DRAWING