

**ZDLD 2.5-2VN****Weidmüller Interface GmbH & Co. KG**

Klingenbergstraße 26

D-32758 Detmold

Germany

www.weidmueller.com

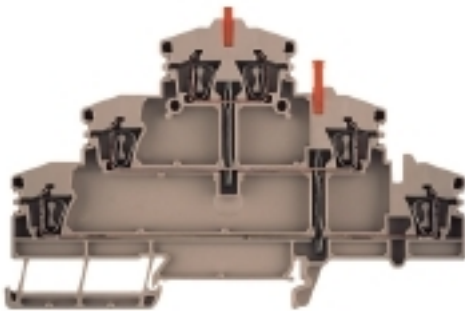
**Product image**

To feed through power, signal, and data is the classical requirement in electrical engineering and panel building. The insulating material, the connection system and the design of the terminal blocks are the differentiating features. A feed-through terminal block is suitable for joining and/or connecting one or more conductors. They could have one or more connection levels that are on the same potential or insulated against one another.

**General ordering data**

Version	Multi-tier modular terminal, Tension-clamp connection, 2.5 mm <sup>2</sup> , 400 V, 20 A, dark beige
Order No.	<a href="#">1782320000</a>
Type	ZDLD 2.5-2VN
GTIN (EAN)	4032248176540
Qty.	25 pc(s).

**ZDLD 2.5-2VN****Weidmüller Interface GmbH & Co. KG**

Klingenbergstraße 26

D-32758 Detmold

Germany

www.weidmueller.com

**Technical data****Dimensions and weights**

Depth	69 mm	Depth (inches)	2.717 inch
Depth including DIN rail	70 mm	Height	110.5 mm
Height (inches)	4.35 inch	Width	5.1 mm
Width (inches)	0.201 inch	Net weight	18.91 g

**Temperatures**

Storage temperature	-25 °C...55 °C	Continuous operating temp., min.	-50 °C
Continuous operating temp., max.	120 °C		

**Material data**

Material	Wemid	Colour	dark beige
UL 94 flammability rating	V-0		

**System specifications**

Version	Tension-clamp connection, Vertically cross-connected, for plug-in cross-connector, One end without connector	End cover plate required	Yes
Number of potentials	1	Number of levels	3
Number of clamping points per level	2	Levels cross-connected internally	Yes
PE connection	No	Rail	TS 35

**Additional technical data**

Explosion-tested version	No	Installation advice	Direct mounting
Number of similar terminals	1	Open sides	right
Type of mounting	Snap-on		

**CSA rating data**

Certificate No. (CSA)	200039-1228250	Current size B (CSA)	15 A
Current size D (CSA)	10 A	Voltage size B (CSA)	300 V
Voltage size D (CSA)	300 V	Wire cross section max. (CSA)	12 AWG
Wire cross section min. (CSA)	26 AWG		

**Conductors for clamping (additional connection)**

Connection type, additional connection Tension-clamp connection

## ZDLD 2.5-2VN

Weidmüller Interface GmbH &amp; Co. KG

Klingenbergstraße 26

D-32758 Detmold

Germany

www.weidmueller.com

## Technical data

## Conductors for clamping (rated connection)

Blade size	0.6 x 3.5 mm	Clamping range, max.	2.5 mm <sup>2</sup>
Clamping range, min.	0.08 mm <sup>2</sup>	Connection cross-section, stranded, max.	4 mm <sup>2</sup>
Connection cross-section, stranded, min.	0.5 mm <sup>2</sup>	Connection direction	top
Gauge to IEC 60947-1	A2	Number of connections	6
Stripping length	10 mm	Type of connection	Tension-clamp connection
Type of connection 2	Tension-clamp connection	Wire connection cross section AWG, max.	AWG 12
Wire connection cross section AWG, min.	AWG 26	Wire connection cross section, finely stranded, max.	2.5 mm <sup>2</sup>
Wire connection cross section, finely stranded, min.	0.5 mm <sup>2</sup>	Wire connection cross-section, finely stranded with wire-end ferrules DIN 46228/1, max.	1.5 mm <sup>2</sup>
Wire connection cross-section, finely stranded with wire-end ferrules DIN 46228/1, min.	0.5 mm <sup>2</sup>	Wire connection cross-section, finely stranded with wire-end ferrules DIN 46228/4, max.	1.5 mm <sup>2</sup>
Wire connection cross-section, finely stranded with wire-end ferrules DIN 46228/4, min.	0.5 mm <sup>2</sup>	Wire connection cross-section, solid core, max.	2.5 mm <sup>2</sup>
Wire connection cross-section, solid core, min.	0.5 mm <sup>2</sup>		

## General

Installation advice	Direct mounting	Rail	TS 35
Standards	IEC 60947-7-1	Wire connection cross section AWG, max.	AWG 12
Wire connection cross section AWG, min.	AWG 26		

## Rating data

Rated cross-section	2.5 mm <sup>2</sup>	Rated voltage	400 V
Rated DC voltage	400 V	Rated current	20 A
Current at maximum wires	20 A	Standards	IEC 60947-7-1
Volume resistance according to IEC 60947-7-x	1.33 mΩ	Rated impulse withstand voltage	6 kV
Power loss in accordance with IEC 60947-7-x	0.77 W	Pollution severity	3

## UL rating data

Certificate No. (UR)	E60693	Conductor size Factory wiring max. (UR)	12 AWG
Conductor size Factory wiring min. (UR)	26 AWG	Conductor size Field wiring max. (UR)	12 AWG
Conductor size Field wiring min. (UR)	26 AWG	Current size B (UR)	15 A
Current size D (UR)	10 A	Voltage size B (UR)	300 V
Voltage size D (UR)	300 V		

## Classifications

ETIM 6.0	EC000897	ETIM 7.0	EC000897
ETIM 8.0	EC000897	ETIM 9.0	EC000897
ECLASS 9.0	27-14-11-20	ECLASS 9.1	27-14-11-20
ECLASS 10.0	27-14-11-20	ECLASS 11.0	27-14-11-20
ECLASS 12.0	27-14-11-20	ECLASS 13.0	27-25-01-02
ECLASS 14.0	27-25-01-02		

Creation date November 21, 2024 4:48:49 PM CET

Catalogue status 09.11.2024 / We reserve the right to make technical changes.

3

## ZDLD 2.5-2VN

**Weidmüller Interface GmbH & Co. KG**  
 Klingenbergstraße 26  
 D-32758 Detmold  
 Germany

www.weidmueller.com

## Technical data

### Environmental Product Compliance

RoHS Compliance Status	Compliant without exemption
REACH SVHC	No SVHC above 0.1 wt%

### Approvals

Approvals



ROHS	Conform
UL File Number Search	UL Website
Certificate No. (UR)	E60693

### Downloads

Approval/Certificate/Document of Conformity	<a href="#">RINA Certificate</a> <a href="#">CE Declaration of Conformity</a> <a href="#">UKCA declaration of conformity</a> <a href="#">Confirmation of Standards EN 45545-2_2020-10</a>
Engineering Data	<a href="#">CAD data – STEP</a>
User Documentation	<a href="#">StorageConditionsTerminalBlocks</a> <a href="#">User Manual Z-Series</a>
Catalogues	<a href="#">Catalogues in PDF-format</a>
Brochures	

**Data sheet**

**ZDLD 2.5-2VN**

**Weidmüller Interface GmbH & Co. KG**  
Klingenbergstraße 26  
D-32758 Detmold  
Germany

[www.weidmueller.com](http://www.weidmueller.com)

**Drawings**

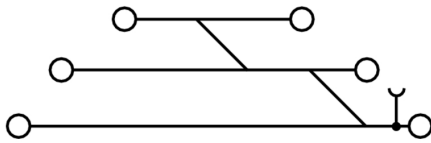

**ZDLD 2.5-2VN**

**Weidmüller Interface GmbH & Co. KG**  
 Klingenbergstraße 26  
 D-32758 Detmold  
 Germany

www.weidmueller.com

**Accessories**

**STR transparent strips**



**General ordering data**

Type	STR 7 F.SCHT 7	Version	
Order No.	<a href="#">0515300000</a>	Terminal markers, Protective cap, 27 x 6.3 mm, Transparent	
GTIN (EAN)	4008190182175		
Qty.	20 pc(s).		

**Z-Series**

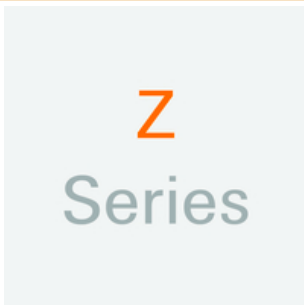

Weidmüller's range of products includes end brackets that guarantee a permanent, reliable mounting on the terminal rail and prevent sliding. Versions with and without screws are available. The end brackets include marking options, also for group markers, and also a test plug holder.

**General ordering data**

Type	ZEW 35/2	Version	
Order No.	<a href="#">8630740000</a>	End bracket, dark beige, TS 35, V-2, Wemid, Width: 8 mm, 100 °C	
GTIN (EAN)	4032248348916		
Qty.	20 pc(s).		
Type	ZEW 35	Version	
Order No.	<a href="#">9540000000</a>	End bracket, dark beige, TS 35, V-2, Wemid, Width: 6 mm, 100 °C	
GTIN (EAN)	4008190956264		
Qty.	20 pc(s).		

**ZDLD 2.5-2VN**

**Weidmüller Interface GmbH & Co. KG**  
 Klingenbergstraße 26  
 D-32758 Detmold  
 Germany

www.weidmueller.com

**Accessories**

**Z-Series**

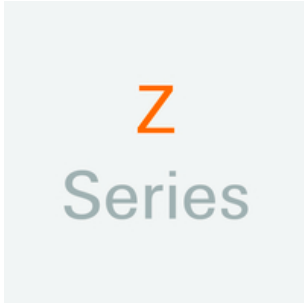

The use of reducing sleeves simplifies the connection of conductors with smaller cross-sections. Conductors can be reliably inserted into the clamping point without the strands fraying. The use of a reducing sleeve centres the conductor in the entry point.

**General ordering data**

Type	ZRH 1.5H/2	Version
Order No.	<a href="#">1678800000</a>	Z-series, Reducing sleeve
GTIN (EAN)	4008190487317	
Qty.	1,000 pc(s).	
Type	ZRH 1.5H/1	Version
Order No.	<a href="#">1678810000</a>	Z-series, Reducing sleeve
GTIN (EAN)	4008190487324	
Qty.	1,000 pc(s).	

**Blank**



ZS markers - in proven MultiCard-format - have been developed specifically for the Z-series. They have a large printing area. The hinged mechanism even allows access to cross-connectors without dismantling. Quick installation is guaranteed by the fact that the single tags are clipped on in strips. The single tags are easy to separate.

- Hinged marker area
- Can be fitted in strips or individually
- Markers in proven MultiCard format

**For custom printing:** Please send us a file of our labeling software M-Print PRO or M-Print PRO Online (without installation) for your labeling specifications.

**General ordering data**

Type	ZS 10/5 MC NE WS	Version
Order No.	<a href="#">1610000000</a>	ZS, Terminal marker, 10 x 5 mm, Pitch in mm (P): 5.00 Weidmueller,
GTIN (EAN)	4008190263171	Allen-Bradley, white
Qty.	480 pc(s).	

## ZDLD 2.5-2VN

Weidmüller Interface GmbH &amp; Co. KG

Klingenbergstraße 26

D-32758 Detmold

Germany

www.weidmueller.com

## Accessories

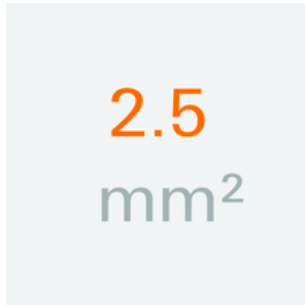
2.5 mm<sup>2</sup>

The plug-in cross-connections feature easy handling and quick installation. This saves a great deal of time during installation in comparison with screwed solutions.

## General ordering data

Type	ZQV 2.5/9	Version
Order No.	<a href="#">1608930000</a>	Accessories, Cross-connector, 24 A
GTIN (EAN)	4008190117009	
Qty.	20 pc(s).	
Type	ZQV 2.5/8	Version
Order No.	<a href="#">1608920000</a>	Accessories, Cross-connector, 24 A
GTIN (EAN)	4008190061531	
Qty.	20 pc(s).	
Type	ZQV 2.5/50	Version
Order No.	<a href="#">1697540000</a>	Accessories, Cross-connector, 24 A
GTIN (EAN)	4008190883256	
Qty.	10 pc(s).	
Type	ZQV 2.5/7	Version
Order No.	<a href="#">1608910000</a>	Accessories, Cross-connector, 24 A
GTIN (EAN)	4008190159665	
Qty.	20 pc(s).	
Type	ZQV 2.5/3	Version
Order No.	<a href="#">1608870000</a>	Accessories, Cross-connector, 24 A
GTIN (EAN)	4008190061630	
Qty.	60 pc(s).	
Type	ZQV 2.5/6	Version
Order No.	<a href="#">1608900000</a>	Accessories, Cross-connector, 24 A
GTIN (EAN)	4008190149840	
Qty.	20 pc(s).	
Type	ZQV 2.5/10	Version
Order No.	<a href="#">1608940000</a>	Accessories, Cross-connector, 24 A
GTIN (EAN)	4008190099060	
Qty.	20 pc(s).	
Type	ZQV 2.5/4	Version
Order No.	<a href="#">1608880000</a>	Accessories, Cross-connector, 24 A
GTIN (EAN)	4008190082208	
Qty.	60 pc(s).	
Type	ZQV 2.5/2	Version
Order No.	<a href="#">1608860000</a>	Z-series, Cross-connector, 24 A
GTIN (EAN)	4008190123680	
Qty.	60 pc(s).	
Type	ZQV 2.5/5	Version
Order No.	<a href="#">1608890000</a>	Accessories, Cross-connector, 24 A
GTIN (EAN)	4008190065713	
Qty.	20 pc(s).	

Creation date November 21, 2024 4:48:49 PM CET

Catalogue status 09.11.2024 / We reserve the right to make technical changes.



## ZDLD 2.5-2VN

**Weidmüller Interface GmbH & Co. KG**  
 Klingenbergstraße 26  
 D-32758 Detmold  
 Germany

www.weidmueller.com

## Accessories

Type	ZQV 2.5/20	Version
Order No.	<a href="#">1908960000</a>	Z-series, Cross-connector, For the terminals, Number of poles: 20
GTIN (EAN)	4032248535293	
Qty.	20 pc(s).	

### 2.5 mm<sup>2</sup>

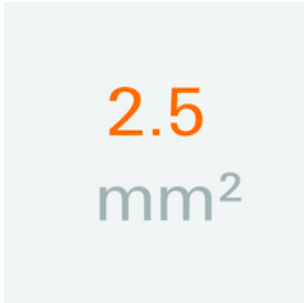

End plates are fitted to the open side of the last modular terminal before the end bracket. The use of an end plate ensures the function of the modular terminal and the specified rated voltage. It guarantees protection against contact with live parts and makes the final terminal finger-proof.

### General ordering data

Type	ZAP/TW ZDLD2.5-2N BL	Version
Order No.	<a href="#">1782350000</a>	Z-series, End plate, Partition plate
GTIN (EAN)	4032248176571	
Qty.	20 pc(s).	
Type	ZAP/TW ZDLD2.5-2N	Version
Order No.	<a href="#">1782340000</a>	Z-series, End plate, Partition plate
GTIN (EAN)	4032248176564	
Qty.	20 pc(s).	

### Blank



ZS markers - in proven MultiCard-format - have been developed specifically for the Z-series. They have a large printing area. The hinged mechanism even allows access to cross-connectors without dismantling. Quick installation is guaranteed by the fact that the single tags are clipped on in strips. The single tags are easy to separate.

- Hinged marker area
- Can be fitted in strips or individually
- Markers in proven MultiCard format

**For custom printing:** Please send us a file of our labeling software M-Print PRO or M-Print PRO Online (without installation) for your labeling specifications.

### General ordering data

Type	ZS 15/5 MC NE WS	Version
Order No.	<a href="#">1646630000</a>	ZS, Terminal marker, 15 x 5 mm, Pitch in mm (P): 5.00 Weidmueller,
GTIN (EAN)	4008190401214	Allen-Bradley, white
Qty.	480 pc(s).	

**ZDLD 2.5-2VN**

**Weidmüller Interface GmbH & Co. KG**  
 Klingenbergstraße 26  
 D-32758 Detmold  
 Germany

www.weidmueller.com

**Accessories**

**Marker holder**



The marker holder offer the possibility of additional mounting of standard markers with a pitch of 5 or 5.1 mm. The angled holders can be optionally snapped together and could be mounted in all standard marking channels of the Klippon® Connect modular terminal blocks. Fitting marker types could be found under the respective accessories of the designation marking holder.

**General ordering data**

Type	BZT 1 ZA WS 10/5	Version
Order No.	<a href="#">1805520000</a>	Accessories, Marker holder
GTIN (EAN)	4032248270248	
Qty.	100 pc(s).	
Type	BZT 1 WS 10/5	Version
Order No.	<a href="#">1805490000</a>	Accessories, Marker holder
GTIN (EAN)	4032248270231	
Qty.	100 pc(s).	

**Slotted screwdriver**

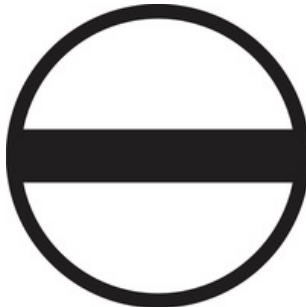

VDE insulated screwdriver sets, for working on live parts up to 1000 V AC and 1500 V DC, DIN EN 60900. IEC 900. Each piece is "GS" safety tested. Blade made from fully hardened, high-alloy chromium-vanadium-molybdenum steel, gun-metal finish.

**General ordering data**

Type	SDIS SLIM 0.6X3.5X100	Version
Order No.	<a href="#">2749610000</a>	Mounting tool, Blade width (B): 3.5 mm, Blade length: 100 mm, Blade thickness (A): 0.6 mm
GTIN (EAN)	4050118896350	
Qty.	1 pc(s).	

**ZDLD 2.5-2VN**

**Weidmüller Interface GmbH & Co. KG**  
 Klingenbergstraße 26  
 D-32758 Detmold  
 Germany

www.weidmueller.com

**Accessories**

**Vertical cross-connections**



A vertical connector allows to connect the two tiers of a terminal block. This allows the potential to be multiplied on several levels on a multi-tier terminal block.

**General ordering data**

Type	ZVQ 2.5/1.5	Version
Order No.	<a href="#">1720700000</a>	Accessories, Cross-connector, 24 A
GTIN (EAN)	4008190374006	
Qty.	50 pc(s).	

**Blank**



ZS markers - in proven MultiCard-format - have been developed specifically for the Z-series. They have a large printing area. The hinged mechanism even allows access to cross-connectors without dismantling. Quick installation is guaranteed by the fact that the single tags are clipped on in strips. The single tags are easy to separate.

- Hinged marker area
- Can be fitted in strips or individually
- Markers in proven MultiCard format

**For custom printing:** Please send us a file of our labeling software M-Print PRO or M-Print PRO Online (without installation) for your labeling specifications.

**General ordering data**

Type	ZS 12/6 MC NE WS	Version
Order No.	<a href="#">1610020000</a>	ZS, Terminal marker, 12 x 6 mm, Pitch in mm (P): 6.00 Weidmueller,
GTIN (EAN)	4008190444600	Allen-Bradley, white
Qty.	400 pc(s).	