

ID	Description	Date	By	Appr.
A				

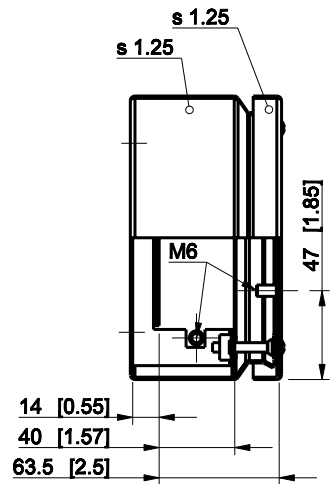
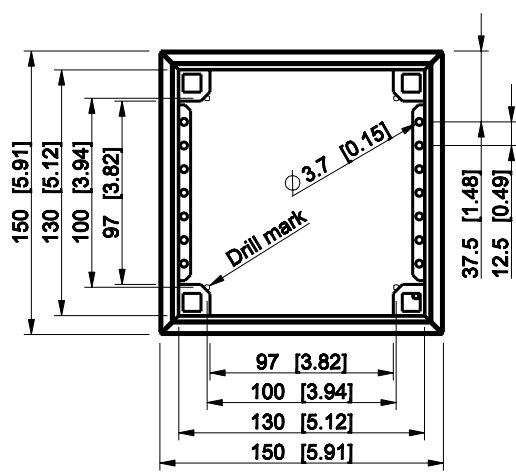
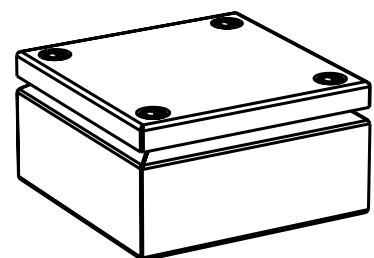
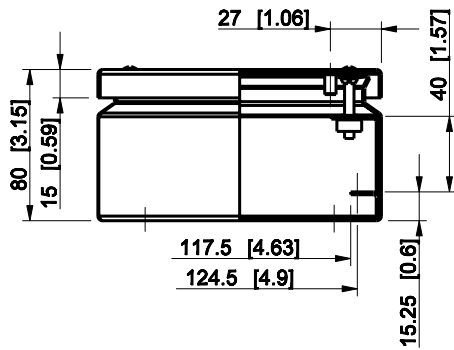

Dimensions in mm [inches]

Material: **Stainless steel, AISI 304** Color:

Supplier: Tool No: Weight [kg]: **1.16** Volume:



FSUP151508

Scale	Date	05.12.08
1:4	By	VLe
-	Checked	
-	Ctrl	

Replaces:	
Replaced:	
Drw No:	A
Ref:	Cubo F
Code:	FSUP151508
Sheet No:	

model FSUP151508 PART
 drawing FSUP DRAWING