

M8 Inductive DC Proximity Switches AE1 Series



Key Features

- Shielded and unshielded models
- LED status indicator 360° visible
- IP67 nickel-plated brass housing
- Short-circuit protection
- Additional cable exit options available
- Nominal sensing range: Shielded 1.5mm; Unshielded 2.5mm
- Long distance AE1: Shielded 2mm; Unshielded 4mm
- UL and cUL approved



Options & Ordering Codes

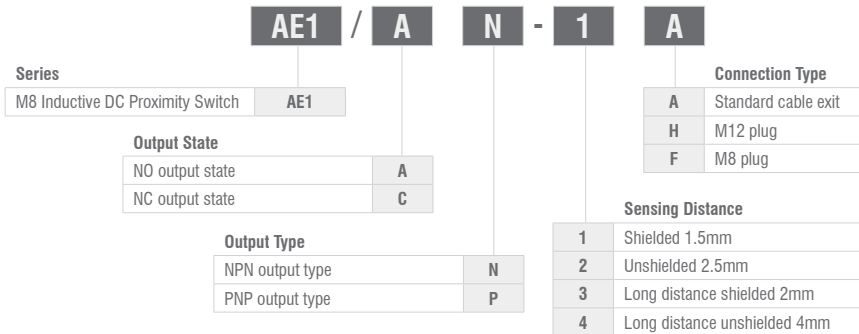

M8 Inductive DC Proximity Switches AE1 Series



Specifications

Models	AE1/**-1*	AE1/**-2*	AE1/**-3*	AE1/**-4*
Nominal Sensing Distance	1.5mm	2.5mm	2mm	4mm
Operating Distance	0 - 1.21mm	0 - 2.02mm	0 - 1.62mm	0 - 3.24
Hysteresis	1 - 20% Sr			
Standard Target	8x8mm FE360		12x12mm FE360	
Repeatability	5%			
Operating Voltage	10 - 30VDC			
Max. Ripple Content	≤10%			
Output Type	NPN or PNP - NO or NC			
Output Current	≤200mA			
Output Voltage Drop	≤1.8V @ 200mA			
No Load Supply Current	10mA			
Leakage Current	≤10μA			
Switching Frequency	5kHz			
Power On Delay	50ms			
Ambient Temperature Range	-25°C to 70°C			
Temperature Drift of Sr	10%			
Short Circuit Protection	•			
Induction Protection	•			
Voltage Reversal Protection	•			
Shocks & Vibrations	IEC 60947-5-2			
Weight	20g connector / 45g cable			
LEDs	Yellow LED output state			
Protection Degree	IP67 (EN 60529)			
EMC	in conformity with the EMC Directive, according to IEC 60947-5-2			
Housing Material	Nickel-plated brass			
Active Head Material	PBT			
Connection	Cable 2m PVC / Plug M8 or M12			
Tightening Torque	3 Nm			

Electrical Connection Diagrams

M12 PNP

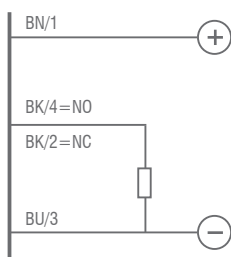

M12 NPN

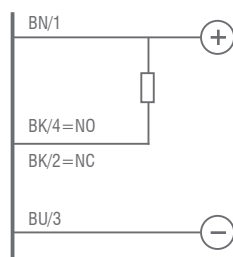

M8 PNP

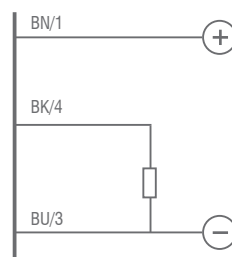

M8 NPN

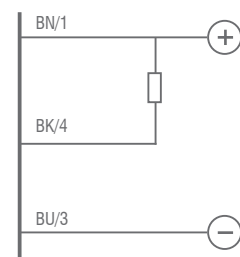

BN - Brown BU - Blue BK - Black WH - White

Connectors

M8

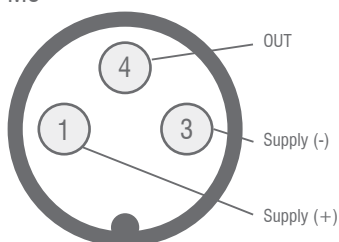

M12 - NO

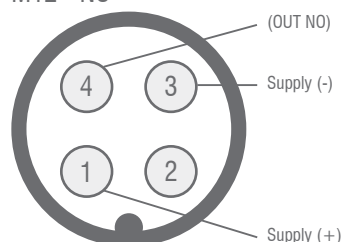

M12 - NC

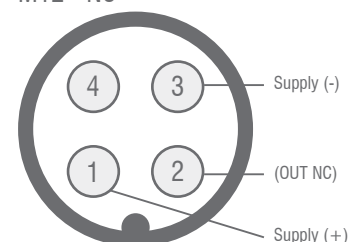

M8 Inductive DC Proximity Switches AE1 Series



Dimensions (mm)

AE1/**-1A & AE1/**-3A

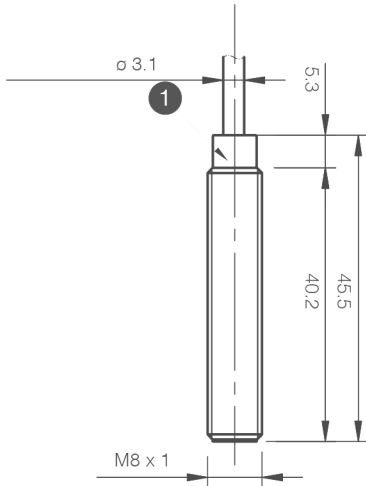

AE1/**-1F & AE1/**-3F

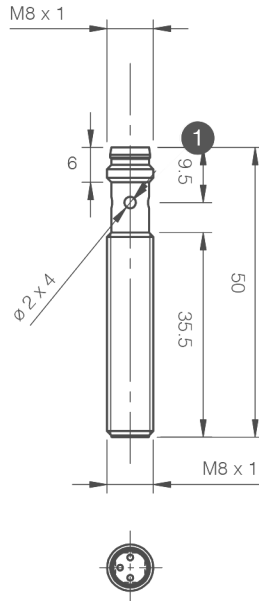

AE1/**-1H & AE1/**-3H

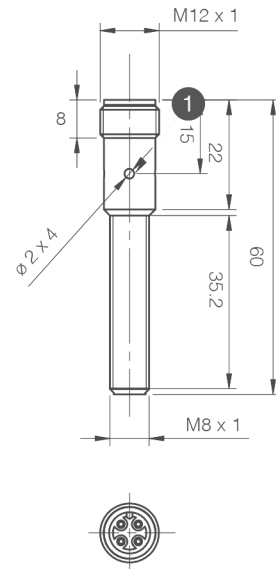

AE1/**-2A & AE1/**-4A

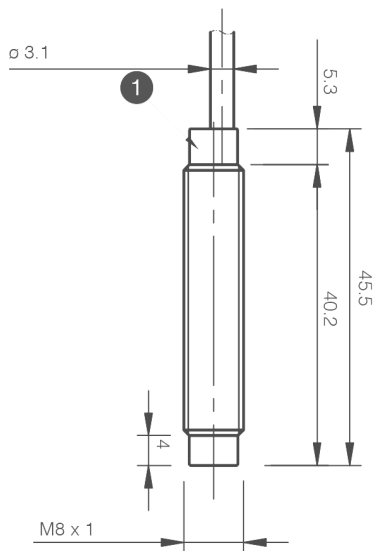

AE1/**-2F & AE1/**-4F

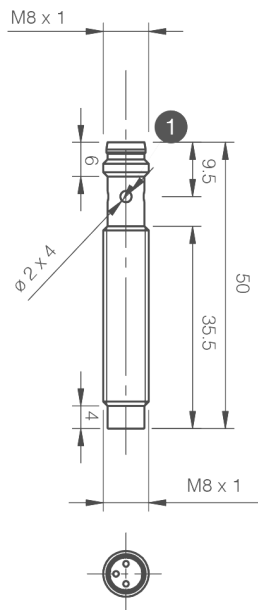

AE1/**-2H & AE1/**-4H

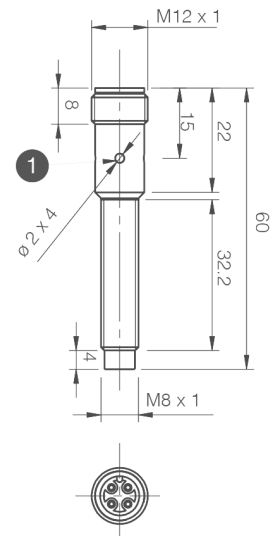

Installation

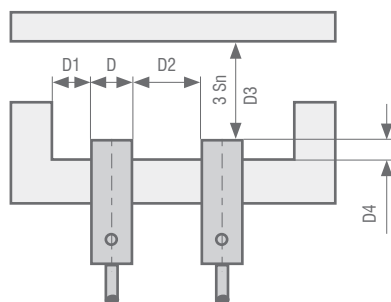

Code	D4	D1	D2	D3
AE1/**-1*	≥1.6mm	≥3.25mm	≥6.5mm	≥4.5mm
AE1/**-2*	≥5mm	≥6.5mm	≥13mm	≥7.5mm
AE1/**-3*	≥1.6mm	≥3.25mm	≥6.5mm	≥6mm
AE1/**-4*	≥8mm	≥6.5mm	≥13mm	≥12mm

1 LED