

1:4

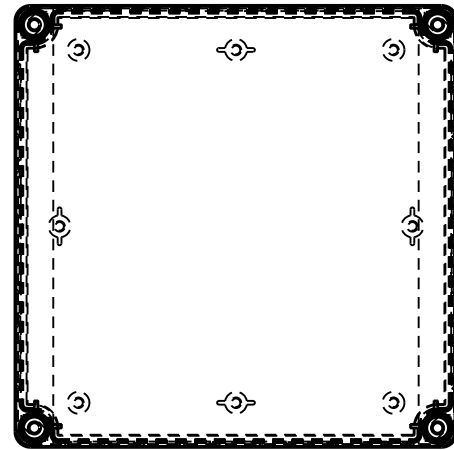

Toleranssi/Tolerance ISO 2768-m	
>0,5 =3	±0,1
>3 =6	±0,1
>6 =30	±0,2
>30 =120	±0,3
>120 =400	±0,5
>400 =1000	±0,8

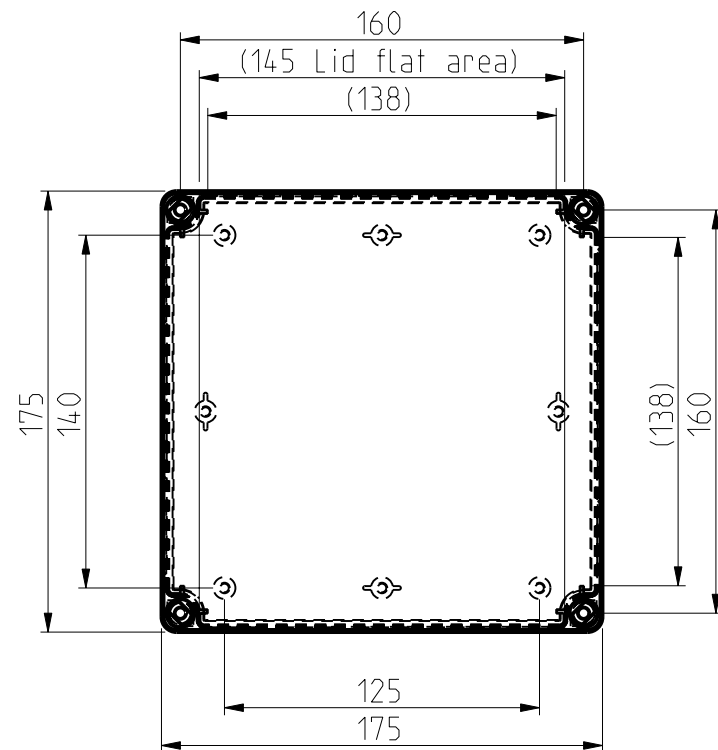
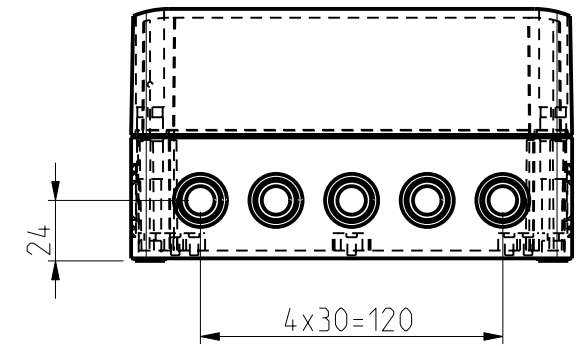
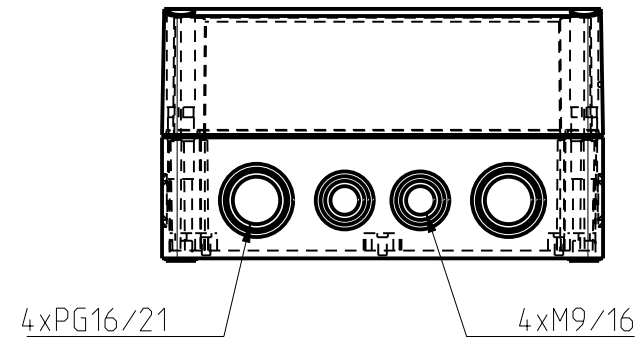
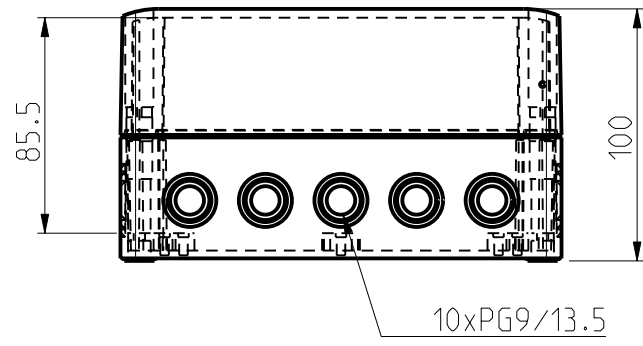
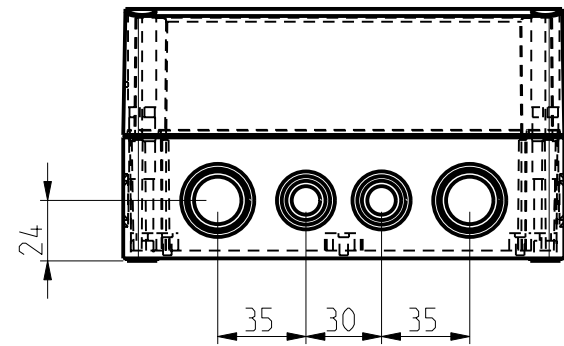

ENSTO		
ENSTO CONTROL OY		
Scale/Suhde	Date/Pvm	26-11-01
1:3	By/Piirt	
-	Chk/Tark	-
-	Ctrl/Hyv	-

CUBO S
SPCK 181810 G/T

Replays:	-
Korvaa:	-
Replaced:	-
Korvattu:	-
Drw No:	-
Piir.no:	-
Ref:	-
Liittyy:	-
Code:	-
Koodi:	-
Sheet No:	1 (1)
Sivu no:	