

# MAD

Mild steel, double door enclosure



HOFFMAN

CONNECT AND PROTECT

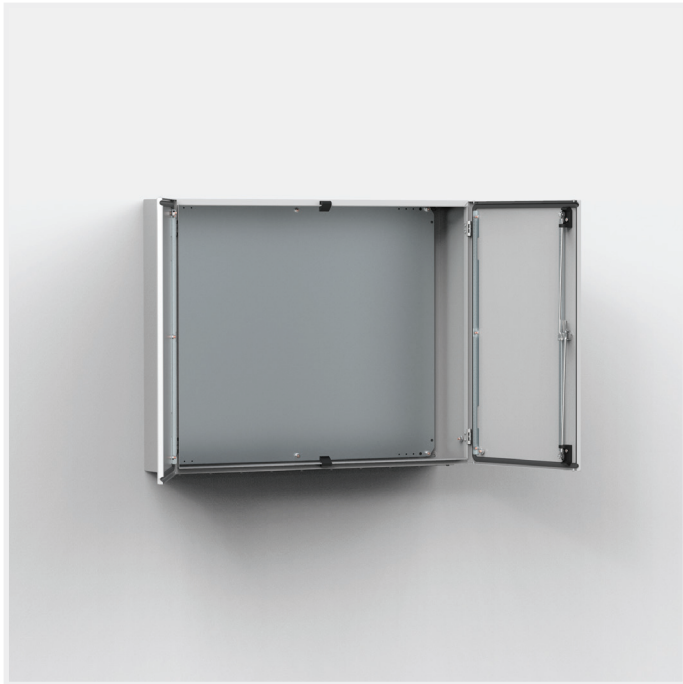

IP 55 | TYPE 12 | IK 10



The mild steel double door wall mounted enclosure range, MAD, is ideal for installation in confined spaces where a single door, when opened, would take up too much space in front of the enclosure. The doors' loading capacity also increases as it is divided over two doors. With a IP 55 protection degree, components inside the enclosure are well protected and makes it well suited for many different applications.

**Material:** Body: 1.5 mm mild steel. Gland plate: 1.4 mm mild steel. Door: 2 mm mild steel Mounting plate: 2 mm galvanized steel / 2.5 mm MAD1001030R5 and above.

**Body:** Folded and seam welded. Four 8.5 mm diameter holes for wall fixing, pressed out in 20.4 mm diameter x 2 mm depressions, to allow air circulation around the rear part of the enclosure.

**Door:** Surface mounted with 130° opening. Concealed removable hinges with captive pin. Inner M6 welded studs to mount door profiles MMDP. Two removable mounting profiles on the right hand door and two on the left hand door. Sealing is ensured by an injected one piece polyurethane gasket.

**Lock:** Customized lock with double-bit for easy opening of the door. Double-bit 3 mm insert and 90° movement. Espagnolette three point locking. Other inserts are available as an accessory.

**Mounting plate:** The mounting plate is marked vertically at 10 mm intervals, for easy horizontal positioning of equipment. On the top and bottom there are holes to facilitate cable fixing. Fixed onto M8 press welded studs to the rear of the enclosure. All sides, from 800 mm and above, are strengthened by folded edges. By using the AMG accessory, the mounting plate position can be adjusted to any depth.

**Gland Plate Opening:** Situated at the far rear of the enclosure, to make cabling onto the mounting plate easier.

**Protection:** IP 55 | TYPE 12 | IK 10. For outdoor installation, the use of a rain hood, ARF, and 100% polyester paint coating plus corrosion protection primer is recommended. Resistance to corrosion must be taken into consideration for outdoor and indoor applications.

**Finish:** RAL 7035 structured powder coating.

**Delivery:** Enclosure with doors and mounting plate (not included for item numbers ending with PER5). Two door mounting profiles on each door. Gland plate(s) with gasket(s), metallic double-bit 3 mm key, and mounting accessories. Earthing facilities.

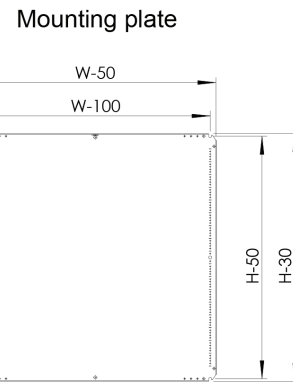
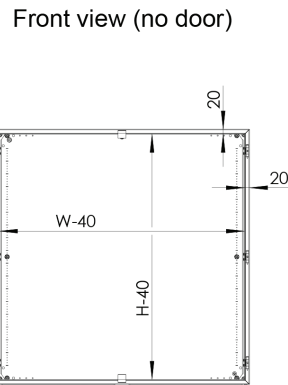
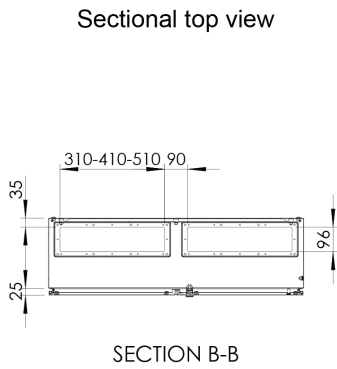
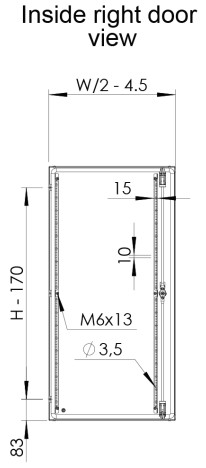
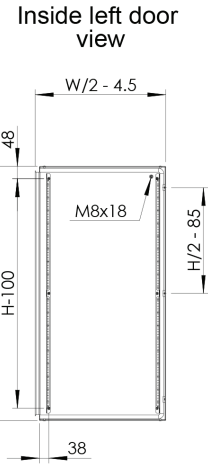
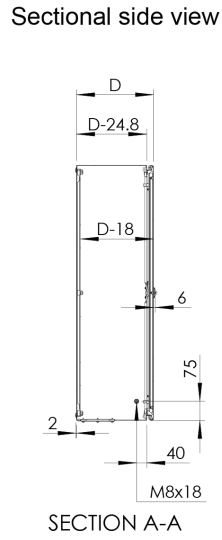
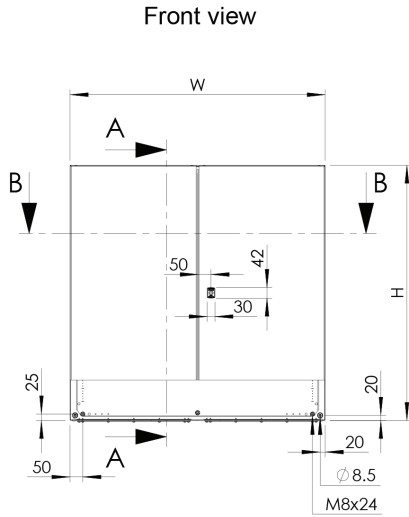

With mounting plate

H	W	D	h	w	d	Size	Type	Openings	N° of locks	Item no.
600	800	300	570	750	282	310 × 96	2	2	1*	MAD0608030R5
800	1200	300	770	1150	282	510 × 96	4	2	1*	MAD0801230R5
1000	1000	300	970	950	282	410 × 96	3	2	1*	MAD1001030R5
1200	1000	300	1170	950	282	410 × 96	3	2	1*	MAD1201030R5
1200	1200	300	1170	1150	282	510 × 96	4	2	1*	MAD1201230R5
1400	1000	300	1370	950	282	410 × 96	3	2	1*	MAD1401030R5

Without mounting plate

H	W	D	Size	Type	Openings	N° of locks	Item no.
600	800	300	310 × 96	2	2	1*	MAD0608030PER5
800	1200	300	510 × 96	4	2	1*	MAD0801230PER5
1000	1000	300	410 × 96	3	2	1*	MAD1001030PER5
1200	1000	300	410 × 96	3	2	1*	MAD1201030PER5
1200	1200	300	510 × 96	4	2	1*	MAD1201230PER5
1400	1000	300	410 × 96	3	2	1*	MAD1401030PER5

\* 3 point espagnolette locking.